

Surface Mount Voltage Controlled Oscillator

JTOS-1025P

5V Tuning for PLL IC's 680 to 755 MHz

Features

- low phase noise
- 5V tuning voltage range
- linear tuning characteristics
- aqueous washable

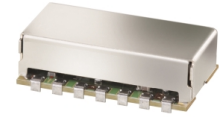

CASE STYLE: BK377
PRICE: \$19.95 ea. QTY (5-49)

Applications

- PLL circuitry
- measurement instrumentation
- frequency synthesizers

Electrical Specifications

FREQUENCY (MHz)		POWER OUTPUT (dBm)	TUNING VOLTAGE (V)		PHASE NOISE (dBc/Hz) SSB at offset frequencies: Typ.				PULLING pk-pk @ 12 dB (MHz)	PUSHING (MHz/V)	TUNING SENSITIVITY (MHz/V)	HARMONICS (dBc)		3 dB MODULATION BANDWIDTH (MHz)	POWER SUPPLY	
Min.	Max.	Typ.	Min.	Max.	1 kHz	10 kHz	100 kHz	1 MHz	Typ.	Typ.	Typ.	Typ.	Max.	Typ.	Voltage (V)	Current (mA) Max.
680	755	+9	0.5	5.0	-70	-94	-114	-134	5.0	0.6	30-40	-27	-20	0.1	12	22

Pin Connections

RF OUT	13
VCC	2
V-TUNE	5
GROUND	1,3,4,6,7,8,9,10,11,12,14

Maximum Ratings

Operating Temperature	-55°C to 85°C
Storage Temperature	-55°C to 100°C
Absolute Max. Supply Voltage (Vcc)	+16V
Absolute Max. Tuning Voltage (Vtune)	+7V

all specifications: 50 ohm system

Outline Drawing

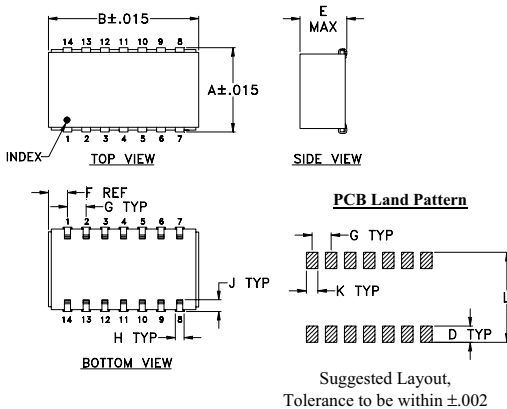

Demo Board MCL PIN: TB-04 Suggested PCB Layout (PL-005)

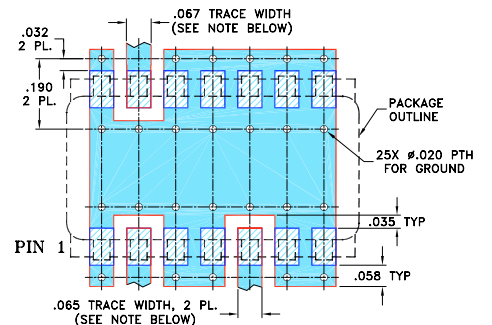

- NOTES: 1. TRACE WIDTH IS SHOWN FOR ROGERS R04350B WITH DIELECTRIC THICKNESS .030" ± .002"; COPPER: 1/2 OZ. EACH SIDE. FOR OTHER MATERIALS TRACE WIDTH MAY NEED TO BE MODIFIED.
2. BOTTOM SIDE OF THE PCB IS CONTINUOUS GROUND PLANE.

- DENOTES PCB COPPER LAYOUT WITH SMOBC (SOLDER MASK OVER BARE COPPER)
- DENOTES COPPER LAND PATTERN FREE OF SOLDER MASK

Outline Dimensions (inch/mm)

A	B	C	D	E	F	G	H	J	K	L	wt
.505	.800	--	.100	.250	.100	.100	.047	.065	.065	.525	grams
12.83	20.32	--	2.54	6.35	2.54	2.54	1.19	1.65	1.65	13.34	3.0



P.O. Box 350166, Brooklyn, New York 11235-0003 (718) 934-4500 Fax (718) 332-4661 For detailed performance specs & shopping online see Mini-Circuits web site



The Design Engineers Search Engine Provides ACTUAL Data Instantly From MINI-CIRCUITS At: www.minicircuits.com

RF/IF MICROWAVE COMPONENTS

REV. B
M102713
JTOS-1025P
FL/TD/CP
080416
Page 1 of 2

Performance Data & Curves

JTOS-1025P

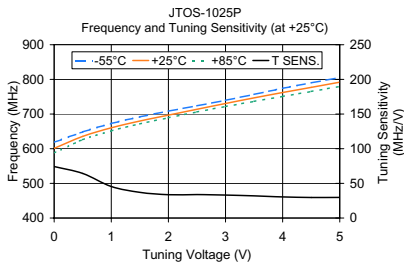

V TUNE	TUNING SENS. (MHz/V)	FREQUENCY (MHz)			POWER OUTPUT (dBm)		
		-55°C	+25°C	+85°C	-55°C	+25°C	+85°C
0.00	74.25	618.42	600.96	587.81	7.23	6.49	4.87
0.50	64.32	648.48	635.61	626.06	7.75	7.94	7.12
1.00	45.46	672.76	660.32	651.44	7.84	8.21	7.59
1.50	37.02	691.93	679.74	671.51	8.41	8.61	7.81
2.00	33.63	708.39	696.92	689.26	8.55	8.91	8.30
2.50	33.85	723.86	713.86	706.14	8.46	9.01	8.36
3.00	33.14	739.79	730.49	721.74	8.18	8.95	8.33
3.50	32.01	756.87	746.67	736.54	8.10	9.08	8.19
4.00	30.49	774.28	762.14	750.97	8.68	8.96	8.12
4.50	29.59	790.17	777.03	765.28	8.75	9.26	8.14
5.00	29.72	805.25	791.89	779.85	8.65	9.15	8.10

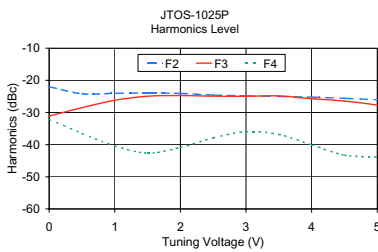
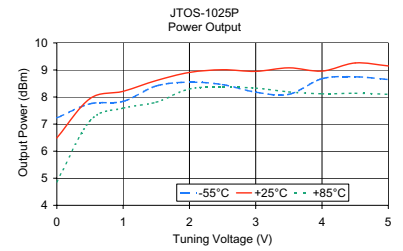

V TUNE	HARMONICS (dBc)			FREQ. PUSHING (MHz/V)
	F2	F3	F4	
0.00	-21.96	-31.12	-32.12	1.28
0.50	-24.17	-28.51	-36.51	0.70
1.00	-24.05	-26.22	-40.38	-0.13
1.50	-23.94	-24.94	-42.60	-0.90
2.00	-24.06	-24.73	-40.89	-0.83
2.50	-24.58	-24.92	-37.92	-1.09
3.00	-24.79	-24.96	-35.96	-1.09
3.50	-25.00	-24.83	-36.83	-0.90
4.00	-25.21	-25.71	-40.05	-0.90
4.50	-25.59	-26.42	-43.25	-0.70
5.00	-26.02	-27.68	-43.85	-0.32

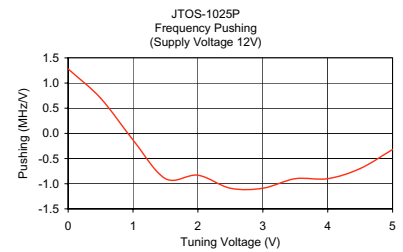

P.O. Box 350166, Brooklyn, New York 11235-0003 (718) 934-4500 Fax (718) 332-4661 For detailed performance specs & shopping online see Mini-Circuits web site



The Design Engineers Search Engine Provides ACTUAL Data Instantly From MINI-CIRCUITS At: www.minicircuits.com

RF/IF MICROWAVE COMPONENTS